

VEHICLE SPECIFICATIONS



09/2011



Using correct and up-to-date technical data and specifications when servicing Land Rover Vehicles is important to ensure a safe and trouble free operation.

This booklet is produced to assist Land Rover Service Technicians in their task of providing first class repairs and service to Land Rover Vehicles, enabling them to achieve the high standard of workmanship customers expect from Land Rover Retailers.

The date printed on the front cover is the issue date of the booklet. The booklet will be updated and reissued periodically to enable the inclusion of new and modified data.

In between these updates we recommend that information issued in TOPIx, which supersedes the information issued here, should be entered by hand into this booklet.

Please note this is a global publication and some of the data supplied will not be applicable to your market, therefore always ensure the data required is relevant to the specification of the vehicle concerned.

Vehicle Identification Number (VIN)	1
Wheel Alignment – Front	5
Wheel Alignment – Rear	10
Vehicle Ride Heights	13
Tire Specification and Pressure	16
Tightening Torques – Wheel Nuts	22
Power Steering Fluid	23
Engine Data	25
Engine Cylinder Numbering and Firing Order	31
Engine Valve Clearances	35
Engine Oil	36
Engine Coolant	40
Accessory Drive Belt Installation	43
Spark Plug Specification and Fuel Octane Rating	57
Cylinder Head – Diesel Engines	59
Cylinder Head – Gasoline Engines	64
Powertrain and Driveline Lubricants	68
Air Conditioning	74

DISCOVERY 4 / LR4

Model Year	Start VIN
2010 (ROW)	AA513326
2010 (NAS)	AA510742
2011 (ROW)	BA551545
2011 (NAS)	BA546956
2012 (ROW)	CA597002
2012 (NAS)	CA596922

Notes

It is essential that the Vehicle Identification Number (VIN) is quoted when ordering parts, and in all associated correspondence.
A quick reference VIN is visible through the left-hand lower corner of the windshield.

DISCOVERY 3 / LR3

Model Year	Start VIN
2007 (ROW)	7A413982
2007 (NAS)	7A405854
2008 (ROW)	8A442166
2008 (NAS)	8A433941
2009 (ROW)	9A494210
2009 (NAS)	9A474451

Notes

It is essential that the Vehicle Identification Number (VIN) is quoted when ordering parts, and in all associated correspondence. A quick reference VIN is visible through the left-hand lower corner of the windshield.

FREELANDER 2 / LR2

Model Year	Start VIN
2007 (ROW)	7H000201
2008 (ROW)	8H057872
2008 (NAS)	8H000212
2009 (ROW)	9H113897
2009 (NAS)	9H113899
2010 (ROW)	AH148520
2010 (NAS)	AH144657
2011 (ROW)	BH216517
2011 (NAS)	BH216528

Notes

It is essential that the Vehicle Identification Number (VIN) is quoted when ordering parts, and in all associated correspondence. A quick reference VIN is visible through the left-hand lower corner of the windshield.

DEFENDER

Model Year	Start VIN
2007	7A732615
2008	8A752597
2009	9A763305
2010	AA781883
2011	BA798536
2012	CA404869

Notes

It is essential that the Vehicle Identification Number (VIN) is quoted when ordering parts, and in all associated correspondence. A quick reference VIN is visible through the left-hand lower corner of the windshield.

Vehicle	Units	CAMBER					
		Left-Hand		Right-Hand		Balance	
		Nominal	Tolerance	Nominal	Tolerance	Nominal	Tolerance
DISCOVERY 4 / LR4 – 2010 MY onwards							
All Derivatives (LHD)	Decimal Degrees	- 0.15°	± 0.75°	- 0.50°	± 0.75°	+ 0.35°	± 0.75°
	Degrees/Minutes	- 0° 09'	± 0° 45'	- 0° 30'	± 0° 45'	+ 0° 21'	± 0° 45'
All Derivatives (RHD)	Decimal Degrees	- 0.50°	± 0.75°	- 0.50°	± 0.75°	0.00°	± 0.75°
	Degrees/Minutes	- 0° 30'	± 0° 45'	- 0° 30'	± 0° 45'	0° 00'	± 0° 45'
DISCOVERY 3 / LR3 – 2005 up to 2010 MY							
All Derivatives (LHD)	Decimal Degrees	- 0.15°	± 0.75°	- 0.50°	± 0.75°	+ 0.35°	± 0.75°
	Degrees/Minutes	- 0° 09'	± 0° 45'	- 0° 30'	± 0° 45'	+ 0° 21'	± 0° 45'
All Derivatives (RHD)	Decimal Degrees	- 0.50°	± 0.75°	- 0.50°	± 0.75°	0.00°	± 0.75°
	Degrees/Minutes	- 0° 30'	± 0° 45'	- 0° 30'	± 0° 45'	0° 00'	± 0° 45'

Note: Pay special attention to 'positive' and 'negative' values and the format of either 'decimal degrees' or 'degrees/minutes' when entering data into your measuring equipment.

Notes

Vehicle	Units	CAMBER					
		Left-Hand		Right-Hand		Balance	
		Nominal	Tolerance	Nominal	Tolerance	Nominal	Tolerance
FREELANDER 2 / LR2 – 2007 up to 2011 MY							
All Derivatives	Decimal Degrees	- 0.50°	± 0.75°	- 0.50°	± 0.75°	0.00°	± 0.75°
	Degrees/Minutes	- 0° 30'	± 0° 45'	- 0° 30'	± 0° 45'	0° 00'	± 0° 45'
FREELANDER 2 / LR2 – 2011 MY onwards							
4WD	Decimal Degrees	- 0.50°	± 0.75°	- 0.50°	± 0.75°	0.00°	± 0.75°
	Degrees/Minutes	- 0° 30'	± 0° 45'	- 0° 30'	± 0° 45'	0° 00'	± 0° 45'
2WD	Decimal Degrees	- 0.43°	± 0.75°	- 0.43°	± 0.75°	0.00°	± 0.75°
	Degrees/Minutes	- 0° 26'	± 0° 45'	- 0° 26'	± 0° 45'	0° 00'	± 0° 45'
DEFENDER – 2007 MY onwards							
All Derivatives	Decimal Degrees	- 0.17°	± 0.75°	- 0.17°	± 0.75°	0.00°	± 1.00°
	Degrees/Minutes	- 0° 10'	± 0° 45'	- 0° 10'	± 0° 45'	0° 00'	± 0° 60'

Note: Pay special attention to 'positive' and 'negative' values and the format of either 'decimal degrees' or 'degrees/minutes' when entering data into your measuring equipment.

Notes

Vehicle	Units	CASTER					
		Left-Hand		Right-Hand		Balance	
		Nominal	Tolerance	Nominal	Tolerance	Nominal	Tolerance
DISCOVERY 4 / LR4 – 2010 MY onwards							
All Derivatives (LHD)	Decimal Degrees	+ 3.86°	± 0.75°	+ 4.17°	± 0.75°	- 0.31°	± 0.75°
	Degrees/Minutes	+ 3° 52'	± 0° 45'	+ 4° 10'	± 0° 45'	- 0° 19'	± 0° 45'
All Derivatives (RHD)	Decimal Degrees	+ 4.02°	± 0.75°	+ 4.02°	± 0.75°	0.00°	± 0.75°
	Degrees/Minutes	+ 4° 01'	± 0° 45'	+ 4° 01'	± 0° 45'	0° 00'	± 0° 45'
DISCOVERY 3 / LR3 – 2005 up to 2010 MY							
All Derivatives (LHD)	Decimal Degrees	+ 3.86°	± 0.75°	+ 4.17°	± 0.75°	- 0.31°	± 0.75°
	Degrees/Minutes	+ 3° 52'	± 0° 45'	+ 4° 10'	± 0° 45'	- 0° 19'	± 0° 45'
All Derivatives (RHD)	Decimal Degrees	+ 4.02°	± 0.75°	+ 4.02°	± 0.75°	0.00°	± 0.75°
	Degrees/Minutes	+ 4° 01'	± 0° 45'	+ 4° 01'	± 0° 45'	0° 00'	± 0° 45'

Note: Pay special attention to 'positive' and 'negative' values and the format of either 'decimal degrees' or 'degrees/minutes' when entering data into your measuring equipment.

Notes

Vehicle	Units	CASTER					
		Left-Hand		Right-Hand		Balance	
		Nominal	Tolerance	Nominal	Tolerance	Nominal	Tolerance
FREELANDER 2 / LR2 – 2007 up to 2011 MY							
All Derivatives	Decimal Degrees	+ 3.25°	± 0.75°	+ 3.25°	± 0.75°	0.00°	± 0.75°
	Degrees/Minutes	+ 3° 15'	± 0° 45'	+ 3° 15'	± 0° 45'	0° 00'	± 0° 45'
FREELANDER 2 / LR2 – 2011 MY onwards							
4WD	Decimal Degrees	+ 3.25°	± 0.75°	+ 3.25°	± 0.75°	0.00°	± 0.75°
	Degrees/Minutes	+ 3° 15'	± 0° 45'	+ 3° 15'	± 0° 45'	0° 00'	± 0° 45'
2WD	Decimal Degrees	+ 3.17°	± 0.75°	+ 3.17°	± 0.75°	0.00°	± 0.75°
	Degrees/Minutes	+ 3° 10'	± 0° 45'	+ 3° 10'	± 0° 45'	0° 00'	± 0° 45'
DEFENDER – 2007 MY onwards							
All Derivatives	Decimal Degrees	+ 3.25°	± 0.75°	+ 3.25°	± 0.75°	0.00°	± 1.00°
	Degrees/Minutes	+ 3° 15'	± 0° 45'	+ 3° 15'	± 0° 45'	0° 00'	± 0° 60'

Note: Pay special attention to 'positive' and 'negative' values and the format of either 'decimal degrees' or 'degrees/minutes' when entering data into your measuring equipment.

Notes

Notes

Vehicle	Units	TOE	
		Nominal	Tolerance
DISCOVERY 4 / LR4 – 2010 MY onwards			
All Derivatives	Decimal Degrees	+ 0.16°	± 0.20°
	Degrees/Minutes	+ 0° 10'	± 0° 12'
DISCOVERY 3 / LR3 – 2005 up to 2010 MY			
All Derivatives	Decimal Degrees	+ 0.16°	± 0.20°
	Degrees/Minutes	+ 0° 10'	± 0° 12'
FREELANDER 2 / LR2 – 2007 MY onwards			
All Derivatives	Decimal Degrees	+ 0.20°	± 0.20°
	Degrees/Minutes	+ 0° 12'	± 0° 12'
DEFENDER – 2007 MY onwards			
All Derivatives	Decimal Degrees	- 0.17°	± 0.17°
	Degrees/Minutes	- 0° 10'	± 0° 10'

Note: Pay special attention to 'positive' and 'negative' values and the format of either 'decimal degrees' or 'degrees/minutes' when entering data into your measuring equipment.

Notes

Vehicle	Units	CAMBER			
		Left-Hand		Right-Hand	
		Nominal	Tolerance	Nominal	Tolerance
DISCOVERY 4 / LR4 – 2010 MY onwards					
Air Suspension (LHD and RHD)	Decimal Degrees	- 0.75°	± 0.75°	- 0.75°	± 0.75°
	Degrees/Minutes	- 0° 45'	± 0° 45'	- 0° 45'	± 0° 45'
Coil Suspension (LHD and RHD)	Decimal Degrees	- 0.50°	± 0.75°	- 0.50°	± 0.75°
	Degrees/Minutes	- 0° 30'	± 0° 45'	- 0° 30'	± 0° 45'
DISCOVERY 3 / LR3 – 2005 up to 2010 MY					
Air Suspension (LHD and RHD)	Decimal Degrees	- 0.75°	± 0.75°	- 0.75°	± 0.75°
	Degrees/Minutes	- 0° 45'	± 0° 45'	- 0° 45'	± 0° 45'
Coil Suspension (LHD and RHD)	Decimal Degrees	- 0.50°	± 0.75°	- 0.50°	± 0.75°
	Degrees/Minutes	- 0° 30'	± 0° 45'	- 0° 30'	± 0° 45'

Note: Pay special attention to 'positive' and 'negative' values and the format of either 'decimal degrees' or 'degrees/minutes' when entering data into your measuring equipment.

Vehicle	Units	CAMBER				Notes
		Left-Hand		Right-Hand		
		Nominal	Tolerance	Nominal	Tolerance	
FREELANDER 2 / LR2 – 2007 up to 2011 MY						
All Derivatives	Decimal Degrees	- 1.95°	± 0.75°	- 1.95°	± 0.75°	
	Degrees/Minutes	- 1° 57'	± 0° 45'	- 1° 57'	± 0° 45'	
FREELANDER 2 / LR2 – 2011 MY onwards						
4WD	Decimal Degrees	- 1.95°	± 0.75°	- 1.95°	± 0.75°	
	Degrees/Minutes	- 1° 57'	± 0° 45'	- 1° 57'	± 0° 45'	
2WD	Decimal Degrees	- 1.85°	± 0.75°	- 1.85°	± 0.75°	
	Degrees/Minutes	- 1° 51'	± 0° 45'	- 1° 51'	± 0° 45'	
DEFENDER – 2007 MY onwards						
All Derivatives	Decimal Degrees	- 0.17°	± 0.75°	- 0.17°	± 0.75°	
	Degrees/Minutes	- 0° 10'	± 0° 45'	- 0° 10'	± 0° 45'	

Note: Pay special attention to 'positive' and 'negative' values and the format of either 'decimal degrees' or 'degrees/minutes' when entering data into your measuring equipment.

Vehicle	Units	TOE							
		Left-Hand		Right-Hand		Thrust Angle		Total Toe	
		Nominal	Tolerance	Nominal	Tolerance	Nominal	Tolerance	Nominal	Tolerance
DISCOVERY 4 / LR4 – 2010 MY onwards									
All Derivatives (LHD and RHD)	Decimal Degrees	+ 0.12°	± 0.10°	+ 0.12°	± 0.10°	0.00°	± 0.14°	+ 0.24°	± 0.14°
	Degrees/Minutes	+ 0° 07'	± 0° 06'	+ 0° 07'	± 0° 06'	0° 00'	± 0° 08'	+ 0° 14'	± 0° 08'
DISCOVERY 3 / LR3 – 2005 up to 2010 MY									
All Derivatives (LHD and RHD)	Decimal Degrees	+ 0.12°	± 0.10°	+ 0.12°	± 0.10°	0.00°	± 0.14°	+ 0.24°	± 0.14°
	Degrees/Minutes	+ 0° 07'	± 0° 06'	+ 0° 07'	± 0° 06'	0° 00'	± 0° 08'	+ 0° 14'	± 0° 08'
FREELANDER 2 / LR2 – 2007 MY onwards									
All Derivatives	Decimal Degrees	+ 0.17°	± 0.14°	+ 0.17°	± 0.14°	0.00°	± 0.14°	+ 0.33°	± 0.20°
	Degrees/Minutes	+ 0° 10'	± 0° 08'	+ 0° 10'	± 0° 08'	0° 00'	± 0° 08'	+ 0° 20'	± 0° 12'
DEFENDER – 2007 MY onwards									
All Derivatives	Decimal Degrees	–	–	–	–	0.00°	± 0.40°	0.00°	± 0.20°
	Degrees/Minutes	–	–	–	–	0° 00'	± 0° 24'	0° 00'	± 0° 12'

Note: Pay special attention to 'positive' and 'negative' values and the format of either 'decimal degrees' or 'degrees/minutes' when entering data into your measuring equipment.

Notes

Vehicle	Ride Height		Notes
	Front	Rear	
DISCOVERY 4 / LR4 – 2010 MY onwards			
All Derivatives	465 ± 12 mm 18.3 ± 0.47 inches	482 ± 13 mm 19 ± 0.51 inches	
DISCOVERY 3 / LR3 – 2007 up to 2010 MY			
All Derivatives	98 ± 6 mm 3.8 ± 0.25 inches	127 ± 6 mm 5 ± 0.25 inches	

Note: DISCOVERY 4 / LR4:

Front Suspension ride height is measured from the center of the wheel to the apex of the wheel arch, vertically through the wheel center line.

Rear Suspension ride height is measured from the center of the wheel to the apex of the wheel arch, vertically through the wheel center line.

Note: DISCOVERY 3 / LR3: ride height calibration can only be performed using Land Rover approved diagnostic equipment.

Front Suspension ride height is measured from the center of the wheel to the bolt-head-center of the lower-suspension-arm, front-bolt.

Rear Suspension ride height is measured from the center of the wheel to the bolt-head-center of the lower-suspension-arm, rear-bolt.

Vehicle	Ride Height		<u>Notes</u>
	Front	Rear	
FREELANDER 2 / LR2 – 2007 up to 2011 MY			
All Derivatives	491 ± 12 mm 19.3 ± 0.47 inches	505 ± 12 mm 19.9 ± 0.47 inches	
FREELANDER 2 / LR2 – 2011 MY onwards			
4WD	491 ± 12 mm 19.3 ± 0.47 inches	505 ± 12 mm 19.9 ± 0.47 inches	
2WD	495 ± 12 mm 19.5 ± 0.47 inches	511 ± 12 mm 20.1 ± 0.47 inches	

Note: FREELANDER 2 / LR2: ride height is measured from the center of the wheel to the apex of the wheel arch, vertically through the wheel center line.

Vehicle	Ride Height		Notes
	Front	Rear	
DEFENDER – 2007 MY onwards			
90 Model	84 ± 15 mm 3.3 ± 0.6 inches	97 ± 15 mm 3.8 ± 0.6 inches	
110 Model	72 ± 15 mm 2.8 ± 0.6 inches	130 ± 15 mm 5.1 ± 0.6 inches	
130 Model	97 ± 15 mm 3.8 ± 0.6 inches	152 ± 15 mm 5.9 ± 0.6 inches	

Note: DEFENDER: ride height is measured vertically from the top of the axle bump stop plate to the underside of the bump stop.

Vehicle	Wheel	Tire	Tire Pressure – bar – (lbf/in ²)			
			Normal		Gross Vehicle Weight	
			Front	Rear	Front	Rear
DISCOVERY 4 / LR4 – 2010 MY onwards						
	7.0J X 17	235/70R 17 111H	2.3 – (33)	2.5 – (36)	2.5 – (36)	2.9 – (42)
	8.0J X 18	255/60R 18 112V				
	8.0J X 19	255/55R 19 111V				
	8.5J X 20	255/50R 20 109Y				
NAS/Canada/Gulf	8.0J X 19	255/55R 19 111V	–	–	2.5 – (36)	2.9 – (42)
	8.5J X 20	255/50R 20 109Y	–	–	2.5 – (36)	2.9 – (42)
Steel Space Saver	5.5J X 19	175/80R 19 122M	4.2 – (60)	4.2 – (60)	4.2 – (60)	4.2 – (60)
DISCOVERY 3 / LR3 – 2007 up to 2010 MY						
	7.0J X 17	235/70R 17 111H	2.3 – (33)	2.5 – (36)	2.3 – (33)	2.9 – (42)
	8.0J X 18	255/60R 18 112V				
	8.0J X 19	255/55R 19 111V				
Steel Space Saver	5.5J X 19	175/80R 19 122M	4.2 – (60)	4.2 – (60)	4.2 – (60)	4.2 – (60)

Notes

Vehicle	Wheel	Tire	Tire Pressure – bar – (lbf/in ²)			
			Normal		Gross Vehicle Weight	
			Front	Rear	Front	Rear
FREELANDER 2 / LR2 – 2007 MY onwards						
	6.5J X 16	215/75R 16 107H or 103H	–	–	2.2 – (32)	2.2 – (32)
	7.5J X 17	235/65R 17 104V or 108V				
	8.0J X 18	235/60R 18 103V or 107V				
	8.0J X 19	235/55R 19 105V	–	–	2.4 – (35)	2.4 – (35)
NAS/Canada	8.0J X 19	235/55R 19 101H / 105H	–	–		
Steel Space Saver	7.0J X 17	225/65R 17 102H	–	–	2.3 – (33)	2.3 – (33)
Space Saver Spare	4.0J X 18	155/85R 18 115M	4.2 – (60)	4.2 – (60)	4.2 – (60)	4.2 – (60)

Note: FREELANDER 2 – tire load capacity depends on tire manufacturer.

Notes

Vehicle	Wheel	Tire	Tire Pressure – bar – (lbf/in ²)			
			Normal		Gross Vehicle Weight	
			Front	Rear	Front	Rear
DEFENDER – 2007 up to 2011 MY						
90 Model	5.5F X 16	7.5 R16 C 116N	2.1 – (30)	2.6 – (38)	–	–
		205/80 R16 104T *				
	5.5J X 16	7.5 R16 C 108N **				
		205/80 R16 104T *				
		7.5 R16 C 116N				
	7J X 16 Alloy	235/85 R16 114Q ***				
235/85 R16 120Q ***						

Note: * December 2008 – 205/80 R16 104T discontinued.

Note: ** April 2009 – 7.5 R16 C (108N) replaced by (112S) and fitment to 'F' rim discontinued.

Note: *** April 2010 onwards – 114Q and 120Q available.

Notes

Vehicle	Wheel	Tire	Tire Pressure – bar – (lbf/in ²)			
			Normal		Gross Vehicle Weight	
			Front	Rear	Front	Rear
DEFENDER – 2007 up to 2011 MY						
110 Model	5.5F X 16	7.5 R16 C 116N	2.1 – (30)	2.6 – (38)	2.1 – (30)	4.5 – (65)
	5.5J X 16	7.5 R16 C 116N				
	5.5J X 16	7.5 R16 C 108N **				
	7J X 16 Alloy	235/85 R16 114Q ***				
235/85 R16 120Q ***						
110 Heavy Duty	6.5F X 16	7.5 R16 C 116N	3.1 – (45)	4.5 – (65)	–	–
	6.5J X 16	7.5 R16 C 116N				
130 Model	6.5F X 16 TT	7.5 R16 C 116N	3.1 – (45)	4.5 – (65)	–	–
130 Double Cab	6.5J X 16 H2	7.5 R16 C 116N				

Note: ** April 2009 – 7.5 R16 C (108N) replaced by (112S) and fitment to 'F' rim discontinued.

Note: *** April 2010 onwards – 114Q and 120Q available.

Notes

Vehicle	Wheel	Tire	Tire Pressure – bar – (lbf/in ²)			
			Normal		Gross Vehicle Weight	
			Front	Rear	Front	Rear
DEFENDER – 2011 MY onwards						
90 Model	5.5F X 16	7.5 R16 C 116N	2.1 – (30)	2.6 – (38)	2.1 – (30)	3.3 – (48)
	5.5J X 16	7.5 R16 C 112S				
	5.5J X 16	7.5 R16 C 116N				
	6.5J X 16	235/85 R16 C 114Q				
	7J X 16 Alloy	235/85 R16 114S				
235/85 R16 114Q						
110 Model	5.5F X 16	7.5 R16 C 116N	2.1 – (30)	3.3 – (48)	2.1 – (30)	4.5 – (65)
	5.5J X 16	7.5 R16 C 116N				
	5.5J X 16	7.5 R16 C 112S				
	6.5J X 16	235/85 R16 C 114Q				
	7J X 16 Alloy	235/85 R16 114S				
235/85 R16 114Q						

Notes

Vehicle	Wheel	Tire	Tire Pressure – bar – (lbf/in ²)			
			Normal		Gross Vehicle Weight	
			Front	Rear	Front	Rear
DEFENDER – 2011 MY onwards						
110 Heavy Duty	6.5J X 16	7.5 R16 C 116N	2.1 – (30)	3.3 – (48)	3.1 – (45)	4.5 – (65)
		235/85 R16 114S				
		235/85 R16 114Q				
130 Model	6.5J X 16	7.5 R16 C 116N	–	–	3.1 – (45)	4.5 – (65)
		235/85 R16 114S				
		235/85 R16 114Q				

Notes

Wheel Nut Torque		Notes
Aluminium Wheel	Steel Wheel	
DISCOVERY 4 / LR4 – 2010 MY onwards		
130 – 150 Nm 96 – 110 lbf.ft.	130 – 150 Nm 96 – 110 lbf.ft.	
DISCOVERY 3 / LR3 – 2007 up to 2010 MY		
130 – 150 Nm 96 – 110 lbf.ft.	130 – 150 Nm 96 – 110 lbf.ft.	
FREELANDER 2 / LR2 – 2007 MY onwards		
113 – 153 Nm 83 – 113 lbf.ft.	113 – 153 Nm 83 – 113 lbf.ft.	
DEFENDER – 2007 MY onwards		
123 – 136 Nm 91 – 100 lbf.ft.	Standard 100 – 115 Nm 74 – 85 lbf.ft.	Heavy Duty 163 – 176 Nm 120 – 130 lbf.ft.

Engine	Fluid Specification	Quantity	Part Number
DISCOVERY 4 / LR4 – 2010 MY onwards			
TDV6 2.7L Diesel	Texaco Cold Climate Fluid 33270	1.2 liters / 2.5 US pints	STC50519 – 1 liter container STC50517 – 2.5 liter container or LR002261
TDV6 3.0L Diesel			
V6 4.0L Gasoline	Texaco Cold Climate Fluid 33270 (ROW) Texaco Cold Climate Fluid 14315 (NAS)	1.4 liters / 3.0 US pints	
V8 5.0L Gasoline			
DISCOVERY 3 / LR3 – 2007 up to 2010 MY			
TDV6 2.7L Diesel	Texaco Cold Climate Fluid 33270	1.2 liters / 2.5 US pints	STC50519 – 1 liter container STC50517 – 2.5 liter container or LR002261
V6 4.0L Gasoline	Texaco Cold Climate Fluid 33270 (ROW) Texaco Cold Climate Fluid 14315 (NAS)	1.4 liters / 3.0 US pints	
V8 4.4L Gasoline			

Notes

Engine	Fluid Specification	Quantity	Part Number
FREELANDER 2 / LR2 – 2007 MY onwards			
TD4 2.2L Diesel	Pentosin CHF202	1.0 liter / 2.1 US pints	LR003401 – 1 liter container
i6 3.2L Gasoline	Pentosin CHF202	1.2 liters / 2.5 US pints	LR003401 – 1 liter container
DEFENDER – 2007 up to 2012 MY			
TDCi 2.4L Diesel	Texaco Cold Climate Fluid 33270	1.6 liters / 3.4 US pints	STC50519 – 1 liter container STC50517 – 2.5 liter container or LR002261
DEFENDER – 2012 MY onwards			
TDCi 2.2L Diesel	Texaco Cold Climate Fluid 33270	1.6 liters / 3.4 US pints	STC50519 – 1 liter container STC50517 – 2.5 liter container or LR002261

Notes

Engine	Engine Capacity	Engine Description	Max. Engine Torque (SAE)	Max. Engine Power (SAE)	Max. Engine Torque (EEC)	Max. Engine Power (EEC)	Comp. Ratio	Bore	Stroke
DISCOVERY 4 / LR4 – 2010 up to 2011 MY									
TDV6 2.7L Diesel	2720 cm ³ 166 in ³	60° V 6 Cylinders 24 Valves	Not Applicable	Not Applicable	440 Nm at 1900 rev/min	140 kW at 4000 rev/min	18.0 : 1 ± 0.5 : 1	81.0 mm 3.189 in	88.0 mm 3.465 in
TDV6 3.0L Diesel	2993 cm ³ 183 in ³	60° V 6 Cylinders 24 Valves	Not Applicable	Not Applicable	600 Nm at 2000 rev/min	180 kW at 4000 rev/min	16.0 : 1 ± 0.5 : 1	84.0 mm 3.307 in	90.0 mm 3.543 in
V6 4.0L Gasoline	3999 cm ³ 244 in ³	60° V 6 Cylinders 12 Valves	269 lbf.ft. at 3000 rev/min	216 BHP at 4500 rev/min	360 Nm at 3000 rev/min	160 kW at 4500 rev/min	9.7 : 1 ± 0.5 : 1	100.4 mm 3.953 in	84.2 mm 3.315 in
V8 5.0L Gasoline	4999 cm ³ 305 in ³	90° V 8 Cylinders 32 Valves	375 lbf.ft. at 3500 rev/min	375 BHP at 6500 rev/min	510 Nm at 3500 rev/min	276 kW at 6500 rev/min	11.5 : 1 ± 0.5 : 1	92.5 mm 3.642 in	93.0 mm 3.661 in

Notes

Engine	Engine Capacity	Engine Description	Max. Engine Torque (SAE)	Max. Engine Power (SAE)	Max. Engine Torque (EEC)	Max. Engine Power (EEC)	Comp. Ratio	Bore	Stroke
DISCOVERY 4 / LR4 – 2011 up to 2012 MY									
TDV6 2.7L Diesel	2720 cm ³ 166 in ³	60° V 6 Cylinders 24 Valves	Not Applicable	Not Applicable	440 Nm at 1900 rev/min	140 kW at 4000 rev/min	18.0 : 1 ± 0.5 : 1	81.0 mm 3.189 in	88.0 mm 3.465 in
TDV6 3.0L Diesel (1)	2993 cm ³ 183 in ³	60° V 6 Cylinders 24 Valves	Not Applicable	Not Applicable	520 Nm at 1500 – 2000 rev/min	155 kW at 4000 rev/min	16.0 : 1 ± 0.5 : 1	84.0 mm 3.307 in	90.0 mm 3.543 in
TDV6 3.0L Diesel (2)	2993 cm ³ 183 in ³	60° V 6 Cylinders 24 Valves	Not Applicable	Not Applicable	600 Nm at 2000 rev/min	180 kW at 4000 rev/min	16.0 : 1 ± 0.5 : 1	84.0 mm 3.307 in	90.0 mm 3.543 in
V6 4.0L Gasoline	3999 cm ³ 244 in ³	60° V 6 Cylinders 12 Valves	269 lbf.ft. at 3000 rev/min	216 BHP at 4500 rev/min	360 Nm at 3000 rev/min	160 kW at 4500 rev/min	9.7 : 1 ± 0.5 : 1	100.4 mm 3.953 in	84.2 mm 3.315 in
V8 5.0L Gasoline	4999 cm ³ 305 in ³	90° V 8 Cylinders 32 Valves	375 lbf.ft. at 3500 rev/min	375 BHP at 6500 rev/min	510 Nm at 3500 rev/min	276 kW at 6500 rev/min	11.5 : 1 ± 0.5 : 1	92.5 mm 3.642 in	93.0 mm 3.661 in

Notes

Engine	Engine Capacity	Engine Description	Max. Engine Torque (SAE)	Max. Engine Power (SAE)	Max. Engine Torque (EEC)	Max. Engine Power (EEC)	Comp. Ratio	Bore	Stroke
DISCOVERY 4 / LR4 – 2012 MY Onwards									
TDV6 2.7L Diesel	2720 cm ³ 166 in ³	60° V 6 Cylinders 24 Valves	Not Applicable	Not Applicable	440 Nm at 1900 rev/min	140 kW at 4000 rev/min	18.0 : 1 ± 0.5 : 1	81.0 mm 3.189 in	88.0 mm 3.465 in
TDV6 3.0L Diesel (1)	2993 cm ³ 183 in ³	60° V 6 Cylinders 24 Valves	Not Applicable	Not Applicable	520 Nm at 1500 – 2000 rev/min	155 kW at 4000 rev/min	16.0 : 1 ± 0.5 : 1	84.0 mm 3.307 in	90.0 mm 3.543 in
TDV6 3.0L Diesel (2)	2993 cm ³ 183 in ³	60° V 6 Cylinders 24 Valves	Not Applicable	Not Applicable	600 Nm at 2000 rev/min	180 kW at 4000 rev/min	16.0 : 1 ± 0.5 : 1	84.0 mm 3.307 in	90.0 mm 3.543 in
TDV6 3.0L Diesel (3)	2993 cm ³ 183 in ³	60° V 6 Cylinders 24 Valves	Not Applicable	Not Applicable	600 Nm at 2000 rev/min	188 kW at 4000 rev/min	16.0 : 1 ± 0.5 : 1	84.0 mm 3.307 in	90.0 mm 3.543 in
V8 5.0L Gasoline	4999 cm ³ 305 in ³	90° V 8 Cylinders 32 Valves	375 lbf.ft. at 3500 rev/min	375 BHP at 6500 rev/min	510 Nm at 3500 rev/min	276 kW at 6500 rev/min	11.5 : 1 ± 0.5 : 1	92.5 mm 3.642 in	93.0 mm 3.661 in

Notes

Engine	Engine Capacity	Engine Description	Max. Engine Torque (SAE)	Max. Engine Power (SAE)	Max. Engine Torque (EEC)	Max. Engine Power (EEC)	Comp. Ratio	Bore	Stroke
DISCOVERY 3 / LR3 – 2007 up to 2010 MY									
TDV6 2.7L Diesel	2720 cm ³ 166 in ³	60° V 6 Cylinders 24 Valves	Not Applicable	Not Applicable	440 Nm at 1900 rev/min	140 kW at 4000 rev/min	18.0 : 1 ± 0.5 : 1	81.0 mm 3.189 in	88.0 mm 3.465 in
V6 4.0L Gasoline	3999 cm ³ 244 in ³	60° V 6 Cylinders 12 Valves	269 lbf.ft. at 3000 rev/min	216 BHP at 4500 rev/min	360 Nm at 3000 rev/min	160 kW at 4500 rev/min	9.7 : 1 ± 0.5 : 1	100.4 mm 3.953 in	84.2 mm 3.315 in
V8 4.4L Gasoline	4394 cm ³ 268 in ³	90° V 8 Cylinders 32 Valves	315 lbf.ft. at 4000 rev/min	300 BHP at 5500 rev/min	425 Nm at 4000 rev/min	220 kW at 5500 rev/min	10.75 : 1 ± 0.5 : 1	88.0 mm 3.465 in	90.3 mm 3.555 in

Notes

Engine	Engine Capacity	Engine Description	Max. Engine Torque (SAE)	Max. Engine Power (SAE)	Max. Engine Torque (EEC)	Max. Engine Power (EEC)	Comp. Ratio	Bore	Stroke
FREELANDER 2 / LR2 – 2007 up to 2011 MY									
TD4 2.2L Diesel	2179 cm ³ (133 in ³)	In-line 4 Cylinder 16 Valves	Not Applicable	Not Applicable	400 Nm at 2000 rev/min	Non DPF 118 kW With DPF 112 kW at 4000 rev/min	16.5 : 1	85.0 mm (3.346 in)	96.0 mm (3.780 in)
i6 3.2L Gasoline	3192 cm ³ (195 in ³)	In-line 6 Cylinder 24 valves	234 lbf.ft. at 3200 rev/min	230 BHP at 6300 rev/min	317 Nm at 3200 rev/min	171 kW at 6300 rev/min	10.8 : 1	84.0 mm (3.307 in)	96.0 mm (3.780 in)
FREELANDER 2 / LR2 – 2011 MY Onwards									
TD4 2.2L Diesel (Low-Power)	2179 cm ³ (133 in ³)	In-line 4 Cylinder 16 Valves	Not Applicable	Not Applicable	420 Nm at 1750 rev/min	Non DPF 110 kW With DPF 110 kW at 4000 rev/min	15.8 : 1	85.0 mm (3.346 in)	96.0 mm (3.780 in)
TD4 2.2L Diesel (High-Power)	2179 cm ³ (133 in ³)	In-line 4 Cylinder 16 Valves	Not Applicable	Not Applicable	420 Nm at 1750 rev/min	Non DPF 140 kW With DPF 140 kW at 3500 rev/min	15.8 : 1	85.0 mm (3.346 in)	96.0 mm (3.780 in)
i6 3.2L Gasoline	3192 cm ³ (195 in ³)	In-line 6 Cylinder 24 valves	234 lbf.ft. at 3200 rev/min	230 BHP at 6300 rev/min	317 Nm at 3200 rev/min	171 kW at 6300 rev/min	10.8 : 1	84.0 mm (3.307 in)	96.0 mm (3.780 in)

Engine	Engine Capacity	Engine Description	Max. Engine Torque (SAE)	Max. Engine Power (SAE)	Max. Engine Torque (EEC)	Max. Engine Power (EEC)	Comp. Ratio	Bore	Stroke
DEFENDER – 2007 up to 2012 MY									
TDCi 2.4L Diesel	2402 cm ³ (146 in ³)	In-line 4 Cylinder 16 Valves	Not Applicable	Not Applicable	360 Nm at 2000 rev/min	90 kW at 3500 rev/min	17.5 : 1	89.9 mm (3.539 in)	94.6 mm (3.724 in)
DEFENDER – 2012 MY onwards									
TDCi 2.2L Diesel	2198 cm ³ (134 in ³)	In-line 4 Cylinder 16 Valves	Not Applicable	Not Applicable	360 Nm at 2000 rev/min	90 kW at 3500 rev/min	15.5 : 1	86 mm (3.386 in)	94.6 mm (3.724 in)

Notes

TD4 2.2L Diesel	TDCi 2.2L and 2.4L Diesel	Notes
<p data-bbox="338 222 464 243" style="text-align: center;">Freelander</p> <div data-bbox="321 264 481 730" style="text-align: center;"> </div> <p data-bbox="235 712 321 733">M128125</p> <p data-bbox="321 743 481 764" style="text-align: center;">Front of Engine</p> <p data-bbox="276 779 526 799" style="text-align: center;">Firing Order: 1 : 3 : 4 : 2</p>	<p data-bbox="1021 222 1130 243" style="text-align: center;">Defender</p> <div data-bbox="1004 264 1147 730" style="text-align: center;"> </div> <p data-bbox="908 712 994 733">M128135</p> <p data-bbox="994 743 1154 764" style="text-align: center;">Front of Engine</p> <p data-bbox="949 779 1199 799" style="text-align: center;">Firing Order: 1 : 3 : 4 : 2</p>	

TDV6 2.7L and 3.0L Diesel

Notes

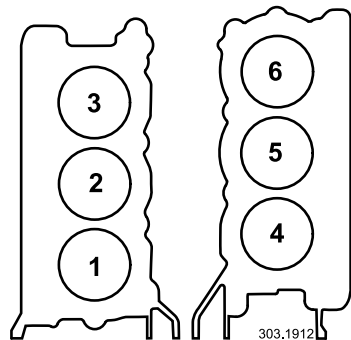

Front of Engine

Firing Order: 1 : 4 : 2 : 5 : 3 : 6

i6 3.2L Gasoline

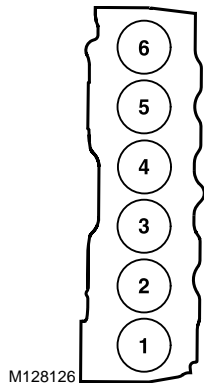

M128126

Front of Engine

Firing Order: 1 : 5 : 3 : 6 : 2 : 4

V6 4.0L Gasoline

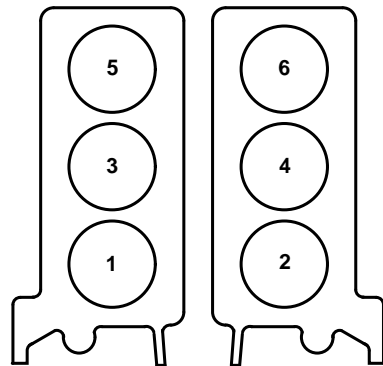

D.303.1629

Front of Engine

Firing Order: 1 : 2 : 3 : 4 : 5 : 6

Notes

V8 Gasoline: 4.4L – 5.0L

Notes

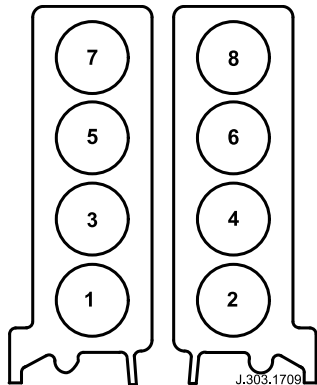

Front of Engine

Firing Order: 1 : 2 : 7 : 3 : 4 : 5 : 6 : 8

Engine	Valve Clearances (Cold)		Notes
	Intake	Exhaust	
Diesel			
TDCi 2.2L (Defender)	Not Applicable	Not Applicable	
TD4 2.2L (Freelander)	Not Applicable	Not Applicable	
TDCi 2.4L	Not Applicable	Not Applicable	
TDV6 2.7L	Not Applicable	Not Applicable	
TDV6 3.0L	Not Applicable	Not Applicable	
Gasoline			
i6 3.2L	Not Applicable	0.45 mm / 0.017 in	
V6 4.0L	Not Applicable	Not Applicable	
V8 4.4L	0.18 to 0.22 mm 0.007 to 0.008 in	0.23 to 0.27 mm 0.009 to 0.010 in	
V8 5.0L	Not Applicable	0.23 to 0.27 mm 0.009 to 0.010 in	

Engine	Market	Oil Specification	Engine Oil Quantity (service fill and filter change)	Engine Oil Quantity (dry fill including filter)
DISCOVERY 4 / LR4 – 2010 MY onwards				
V6 2.7L Diesel	ROW	*5W/30 – WSS–M2C913–B or C	5.45 liters 11.5 US pints	6.55 liters 13.8 US pints
TDV6 3.0L Diesel (with DPF)	EUR	5W/30 – WSS–M2C934–B	5.9 liters 12.4 US pints	6.75 liters 14.2 US pints
TDV6 3.0L Diesel (non DPF)	ROW	*5W/30 – WSS–M2C913–B or C		
V6 4.0L Gasoline	ROW	5W/30 Preferred: WSS–M2C913–B Alternative: ACEA A3/B3	5.7 liters 12.0 US pints	6.4 liters 13.5 US pints
	NAS/Japan	5W/30 – ILSAC GF4 and API SM		
V8 5.0L Gasoline	ROW	WSS–M2C925–A	8.0 liters 16.9 US pints	9.5 liters 20.0 US pints
	NAS	WSS–M2C925–A		
		**API SM and ILSAC GF–4 (top-up only) or **API SN and ILSAC GF–5 (top-up only)		

Note: * In high sulphur markets the oil change service-interval is reduced to 12,000 km (7,500 miles).

Note: ** Maximum top-up of one liter only.

Notes

Land Rover recommends



Engine	Market	Oil Specification	Engine Oil Quantity (service fill and filter change)	Engine Oil Quantity (dry fill including filter)
DISCOVERY 3 / LR3 – 2007 up to 2010 MY				
TDV6 2.7L Diesel	ROW	*5W/30 – WSS–M2C913–B – Only	5.45 liters 11.5 US pints	6.55 liters 13.8 US pints
V6 4.0L Gasoline	ROW	5W/30 Preferred: WSS–M2C913–B Alternative: ACEA A3/B3	5.7 liters 12.0 US pints	6.4 liters 13.5 US pints
	NAS/Japan	5W/30 – ILSAC GF4 and API SM		
V8 4.4L Gasoline	ROW	5W/30 Preferred: WSS–M2C913–B Alternative: ACEA A3/B3	7.7 liters 16.3 US pints	8.0 liters 16.9 US pints
	NAS/Japan	5W/30 – ILSAC GF4 and API SM		

Note: * In high sulphur markets the oil change service-interval is reduced to 12,000 km (7,500 miles).

Notes

Land Rover recommends



Engine	Market	Oil Specification	Engine Oil Quantity (service fill and filter change)	Engine Oil Quantity (dry fill including filter)
FREELANDER 2 / LR2 – 2007 up to 2012 MY				
TD4 2.2L Diesel	ROW	*5W/30 – WSS–M2C913–B or C	5.9 liters 12.5 US pints	6.5 liters 13.7 US pints
i6 3.2L Gasoline	ROW	0W/30 – ACEA A5/B5	up to VIN 3822 7.7 liters 16.3 US pints VIN 3823 onwards 7.5 liters 15.8 US pints	up to VIN 3822 9.3 liters 19.6 US pints VIN 3823 onwards 9.0 liters 19.0 US pints
	NAS	5W/30 meeting specifications ILSAC GF–4 and API SM, or ACEA A1/B1		
FREELANDER 2 / LR2 – 2012 MY onwards				
TD4 2.2L Diesel (with DPF)	EUR	5W/30 – WSS–M2C934–B	5.9 liters 12.5 US pints	6.5 liters 13.7 US pints
TD4 2.2L Diesel (non DPF)	ROW	*5W/30 – WSS–M2C913–B or C		
i6 3.2L Gasoline	ROW	0W/30 – ACEA A5/B5	7.5 liters 15.8 US pints	9.0 liters 19.0 US pints
	NAS	5W/30 meeting specifications ILSAC GF–4 and API SM, or ACEA A1/B1		

Note: * In high sulphur markets the oil change service-interval is reduced to 12,000 km (7,500 miles).

Notes

Land Rover recommends



Engine	Market	Oil Specification	Engine Oil Quantity (service fill and filter change)	Engine Oil Quantity (dry fill including filter)
DEFENDER – 2007 up to 2012 MY				
TDCi 2.4L Diesel	ROW	*5W/30 – WSS–M2C913–B or C	6.85 liters 14.4 US pints	7.2 liters 15.2 US pints
DEFENDER – 2012 MY onwards				
TDCi 2.2L Diesel (with DPF)	ROW	5W/30 – WSS–M2C934–B	6.85 liters 14.4 US pints	7.2 liters 15.2 US pints
TDCi 2.2L Diesel (non DPF)	ROW	*5W/30 – WSS–M2C913–B or C		

Note: * In high sulphur markets the oil change service-interval is reduced to 12,000 km (7,500 miles).

Notes

Land Rover recommends



Engine	Coolant Specification	Cooling System Capacity	Coolant Concentration
DISCOVERY 4 / LR4 – 2010 MY onwards			
TDV6 2.7L Diesel	Texaco (XLC)	Base: 16.7 liters / 35.3 US pints Base + FFBH: 18.0 liters / 38.0 US pints Base + Rear Heater: 19.2 liters / 40.6 US pints Base + FFBH + Rear Heater: 20.5 liters / 43.3 US pints	50% water/50% coolant
TDV6 3.0L Diesel	Texaco (XLC)	Base: 11.5 liters / 24.3 US pints Base + FFBH: 12.8 liters / 27.0 US pints Base + Rear Heater: 14 liters / 29.6 US pints Base + FFBH + Rear Heater: 15.3 liters / 32.3 US pints	50% water/50% coolant
V6 4.0L Gasoline	Texaco (XLC)	Base: 17.0 liters / 35.9 US pints Base + Rear Heater: 19.5 liters / 41.2 US pints	50% water/50% coolant
V8 5.0L Gasoline	Texaco (XLC)	Base: 10.8 liters / 22.8 US pints Base + Rear Heater: 13.3 liters / 28.1 US pints	50% water/50% coolant

Note: Fuel Fired Booster Heater (FFBH).

Notes

Engine	Coolant Specification	Cooling System Capacity	Coolant Concentration
DISCOVERY 3 / LR3 – 2007 up to 2010 MY			
TDV6 2.7L Diesel	Texaco (XLC)	Base: 16.7 liters / 35.3 US pints Base + FFBH: 18.0 liters / 38.0 US pints Base + Rear Heater: 19.2 liters / 40.6 US pints Base + FFBH + Rear Heater: 20.5 liters / 43.3 US pints	50% water/50% coolant
V6 4.0L Gasoline	Texaco (XLC)	Base: 17.0 liters / 35.9 US pints Base + Rear Heater: 19.5 liters / 41.2 US pints	50% water/50% coolant
V8 4.4L Gasoline	Texaco (XLC)	Base: 14.0 liters / 29.6 US pints Base + Rear Heater: 16.5 liters / 34.9 US pints	50% water/50% coolant

Note: Fuel Fired Booster Heater (FFBH).

Notes

Engine	Coolant Specification	Cooling System Capacity	Coolant Concentration
FREELANDER 2 / LR2 – 2007 up to 2011 MY			
TD4 2.2L Diesel	Texaco XLC	Base: 7.6 liters / 16.0 US pints Base + FFBH: 8.0 liters / 17.0 US pints	50% water/50% coolant
i6 3.2L Gasoline	Texaco XLC	8.0 liters / 17.0 US pints	50% water/50% coolant
FREELANDER 2 / LR2 – 2011 MY onwards			
TD4 2.2L Diesel with manual transmission	Texaco XLC	Base: 8.0 liters / 17.0 US pints Base + FFBH: 8.2 liters / 17.3 US pints	50% water/50% coolant
TD4 2.2L Diesel with automatic transmission	Texaco XLC	Base: 8.2 liters / 17.3 US pints Base + FFBH: 8.4 liters / 17.7 US pints	50% water/50% coolant
i6 3.2L Gasoline	Texaco XLC	8.0 liters / 17.0 US pints	50% water/50% coolant
DEFENDER – 2007 MY onwards			
TDCi 2.4L Diesel	Texaco XLC	8.2 liters / 17.3 US pints	50% water/50% coolant
TDCi 2.2L Diesel	Texaco XLC	8.2 liters / 17.3 US pints	50% water/50% coolant

Note: Fuel Fired Booster Heater (FFBH).

Notes

DISCOVERY 4 / LR4

TDV6 2.7L Diesel

Notes

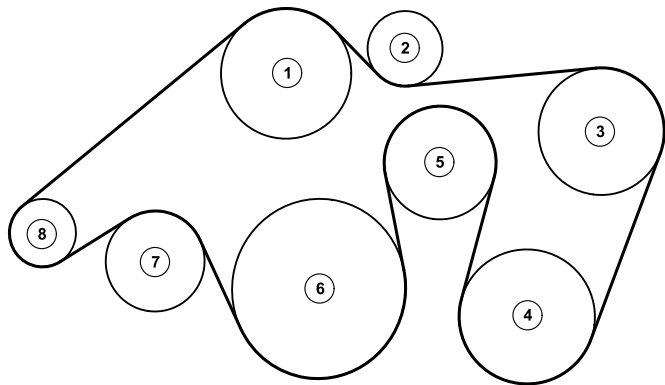

1. Cooling fan
2. Idler
3. Power steering pump
4. Air conditioning compressor
5. Coolant pump
6. Crankshaft pulley
7. Tensioner
8. Generator

M128144

DISCOVERY 4 / LR4

TDV6 3.0L Diesel

Notes

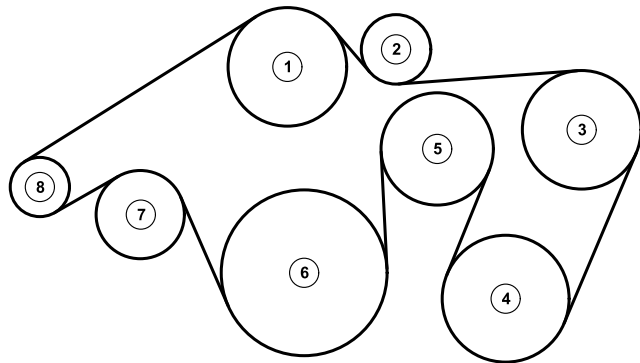

1. Cooling fan
2. Idler
3. Power steering pump
4. Air conditioning compressor
5. Coolant pump
6. Crankshaft pulley
7. Tensioner
8. Generator

M128183

DISCOVERY 4 / LR4

V6 4.0L Gasoline

Notes

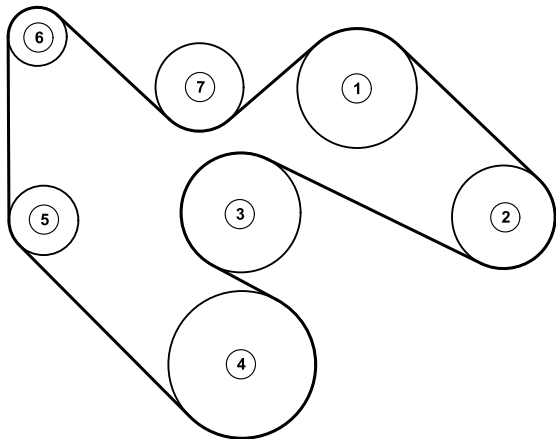

1. Power steering pump
2. Air conditioning compressor
3. Coolant pump
4. Crankshaft pulley
5. Tensioner
6. Generator
7. Idler

M128145

DISCOVERY 4 / LR4

V8 5.0L Gasoline

Notes

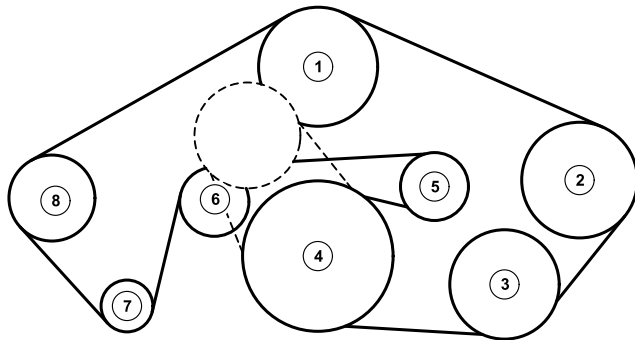

Primary Drive Belt

1. Coolant pump
2. Power steering pump
3. Air conditioning compressor
4. Crankshaft pulley
5. Tensioner
6. Idler
7. Generator
8. Idler

M128179

DISCOVERY 4 / LR4

V8 5.0L Gasoline

Notes

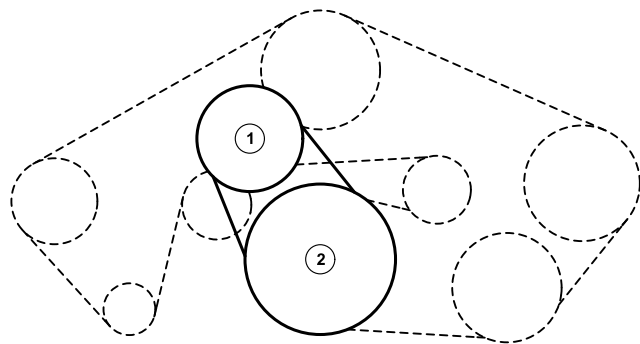

Secondary Drive Belt

1. Cooling fan
2. Crankshaft pulley

M128180

DISCOVERY 3 / LR3

TDV6 2.7L Diesel

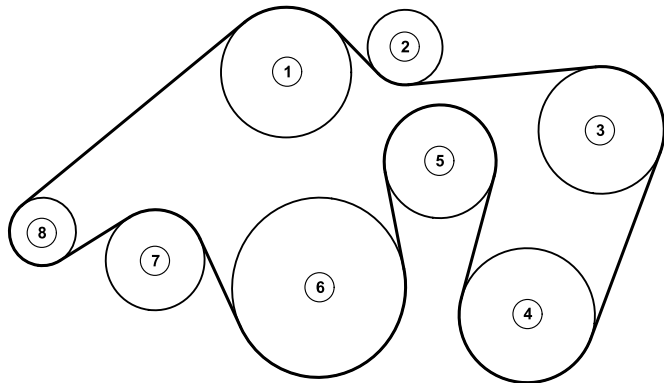

1. Cooling fan
2. Idler
3. Power steering pump
4. Air conditioning compressor
5. Coolant pump
6. Crankshaft pulley
7. Tensioner
8. Generator

M128144

Notes

DISCOVERY 3 / LR3

V6 4.0L Gasoline

Notes

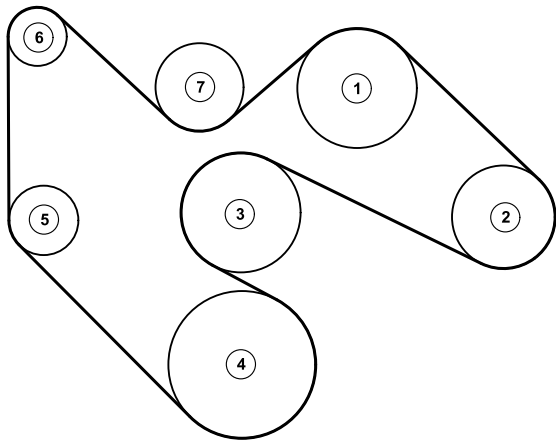

1. Power steering pump
2. Air conditioning compressor
3. Coolant pump
4. Crankshaft pulley
5. Tensioner
6. Generator
7. Idler

M128145

DISCOVERY 3 / LR3

V8 4.4L Gasoline

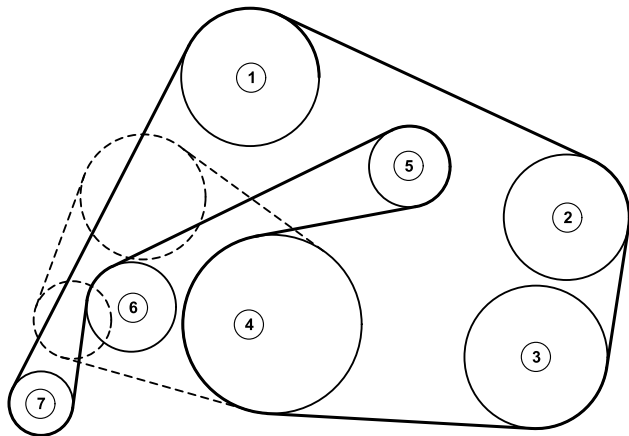

Primary Drive Belt

1. Coolant pump
2. Air conditioning compressor
3. Power steering pump
4. Crankshaft pulley
5. Tensioner
6. Idler
7. Generator

M128146

Notes

DISCOVERY 3 / LR3

V8 4.4L Gasoline

Notes

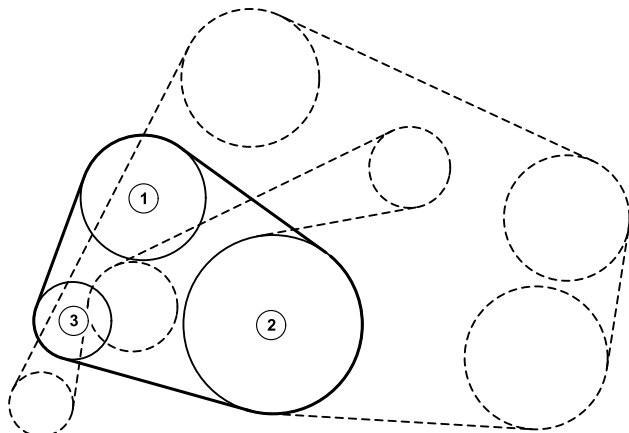

Secondary Drive Belt

- 1. Cooling fan
- 2. Crankshaft pulley
- 3. Tensioner

M128147

FREELANDER 2 / LR2

TD4 2.2L Diesel

Notes

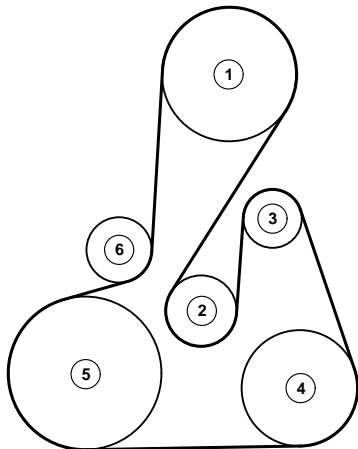

1. Power steering pump
2. Idler
3. Generator
4. Air conditioning compressor
5. Crankshaft pulley
6. Tensioner

M128149

FREELANDER 2 / LR2

i6 3.2L Gasoline

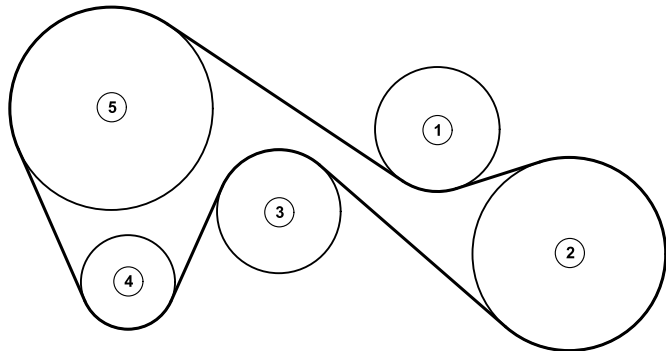

1. Idler
2. Power steering pump and coolant pump
3. Tensioner
4. Drive pulley
5. Air conditioning compressor

M128150

Notes

DEFENDER

TDCi 2.4L Diesel

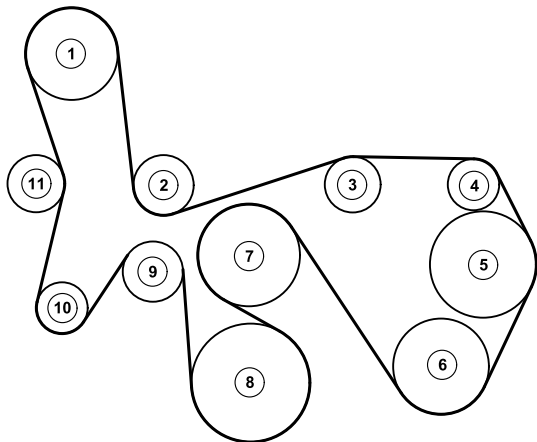

1. Air conditioning compressor
2. Idler
3. Idler
4. Vacuum pump
5. Coolant pump
6. Power steering pump
7. Cooling fan
8. Crankshaft pulley
9. Tensioner
10. Generator
11. Idler

M128148

Notes

DEFENDER

TDCi 2.2L Diesel - with Air Conditioning

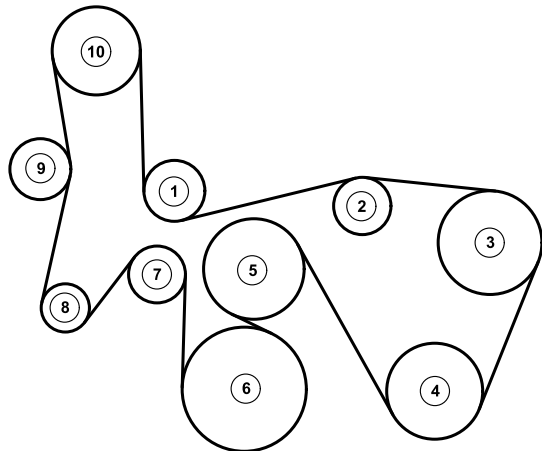

1. Idler
2. Idler
3. Coolant pump
4. Power steering pump
5. Cooling fan
6. Crankshaft
7. Tensioner
8. Generator
9. Idler

M128209

Notes

DEFENDER

TDCi 2.2L Diesel - without Air Conditioning

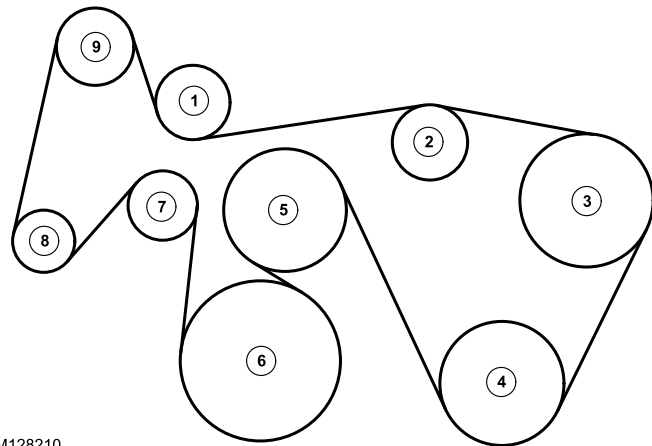

1. Idler
2. Idler
3. Coolant pump
4. Power steering pump
5. Cooling fan
6. Crankshaft
7. Tensioner
8. Generator
9. Idler

M128210

Notes

Engine	Spark Plug Type	Spark Plug Gap	Fuel Octane Rating Recommended	Notes
DISCOVERY 4 / LR4 – 2010 up to 2011.5 MY				
V6 4.0L	Honeywell AGSF24N	1.4 mm / 0.055 in	95 RON or greater 91 AKI or greater	
V8 5.0L	NGK Iridium ILKAR6C10 or NGK Iridium ILKAR7C10	0.9 to 1.0 mm 0.035 to 0.039 in	95 RON or greater 91 AKI or greater	
DISCOVERY 4 / LR4 – 2011.5 MY onwards				
V6 4.0L	Honeywell AGSF24N	1.4 mm / 0.055 in	95 RON or greater 91 AKI or greater	
V8 5.0L	NGK Iridium ILKAR7C10	0.9 to 1.0 mm 0.035 to 0.039 in	95 RON or greater 91 AKI or greater	

Note: Using a lower than recommended fuel octane rating can cause engine knock and if severe can lead to engine damage.

Note: Research Octane Number (RON). Anti Knock Index (AKI).

Engine	Spark Plug Type	Spark Plug Gap	Fuel Octane Rating Recommended	Notes
DISCOVERY 3 / LR3 – 2007 MY onwards				
V6 4.0L	Honeywell AGSF24PM – see note *	1.4 mm / 0.055 in	95 RON or greater 91 AKI or greater	
	Honeywell AGSF24N	1.4 mm / 0.055 in	95 RON or greater 91 AKI or greater	
V8 4.4L	NGK Iridium IFR5N-10	0.9 to 1.0 mm 0.035 to 0.039 in	95 RON or greater 91 AKI or greater	
FREELANDER 2 / LR2 – 2007 MY onwards				
i6 3.2L	NGK LFR6D – see note **	0.6 mm / 0.023 in	95 RON or greater 91 AKI or greater	
	NGK Iridium ILFR6B	0.8 mm / 0.031 in		

Note: Using a lower than recommended fuel octane rating can cause engine knock and if severe can lead to engine damage.

Note: Research Octane Number (RON). Anti Knock Index (AKI).

Note: * DISCOVERY 3 / LR3: Honeywell AGSF24PM was superseded by Honeywell AGSF24N at VIN 6A350373.

Note: ** FREELANDER 2 / LR2: NGK LFR6D has been superseded by NGK Iridium ILFR6B.

TD4 2.2L (Freelander)

Notes

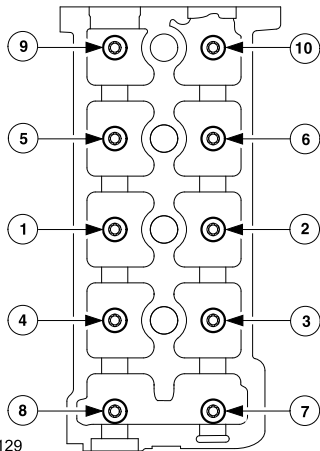

front of engine

Apply each step in numerical sequence shown:

1. Pre-tighten 1 to 10 – 20 Nm / 15 lbf.ft.
2. Tighten 1 to 10 – 60 Nm / 44 lbf.ft.
3. Angular tighten 1 to 10 – 220 degrees

Note: Always use new bolts.

TDCi 2.2L (Defender)

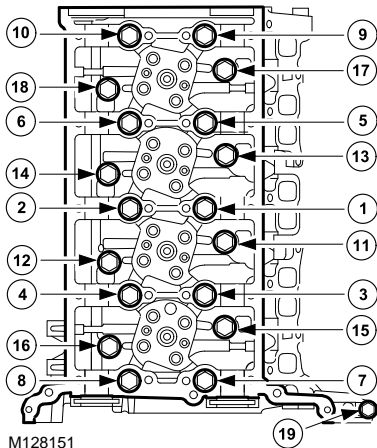
Notes

front of engine

Apply each step in numerical sequence shown:

1. Tighten 1 to 10 – 10 Nm / 7 lbf.ft.
2. Tighten 11 to 18 – 5 Nm / 4 lbf.ft.
3. Tighten 1 to 10 – 20 Nm / 15 lbf.ft.
4. Tighten 11 to 18 – 10 Nm / 7 lbf.ft.
5. Tighten 1 to 10 – 35 Nm / 26 lbf.ft.
6. Tighten 11 to 18 – 20 Nm / 15 lbf.ft.
7. Tighten 1 to 10 – 45 Nm / 33 lbf.ft.
8. Tighten 11 to 18 – 26 Nm / 19 lbf.ft.
9. Angular tighten 1 to 10 – 90 degrees
10. Angular tighten 11 to 18 – 90 degrees
11. Angular tighten 1 to 10 – 90 degrees
12. Angular tighten 11 to 18 – 90 degrees
13. Tighten 19 – 10 Nm / 7 lbf.ft.

Note: Always use new bolts.

TDCi 2.4L

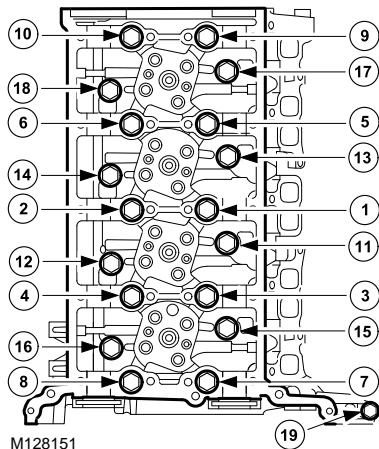
Notes

front of engine

Apply each step in numerical sequence shown:

1. Tighten 1 to 10 – 20 Nm / 15 lbf.ft.
2. Tighten 11 to 18 – 10 Nm / 7 lbf.ft.
3. Tighten 1 to 10 – 40 Nm / 29 lbf.ft.
4. Tighten 11 to 18 – 20 Nm / 15 lbf.ft.
5. Tighten 1 to 10 – 180 degrees
6. Tighten 11 to 18 – 180 degrees
7. Tighten 19 – 10 Nm / 7 lbf.ft.

Note: Always use new bolts.

TDV6 2.7L

Apply each step in numerical sequence shown:

- | | |
|--|--|
| 1. Tighten 1 to 8 – 20 Nm / 14 lbf.ft. | 3. Tighten 1 to 8 – 80 Nm / 59 lbf.ft. |
| 2. Tighten 1 to 8 – 40 Nm / 29 lbf.ft. | 4. Tighten 1 to 8 – 180 degrees |

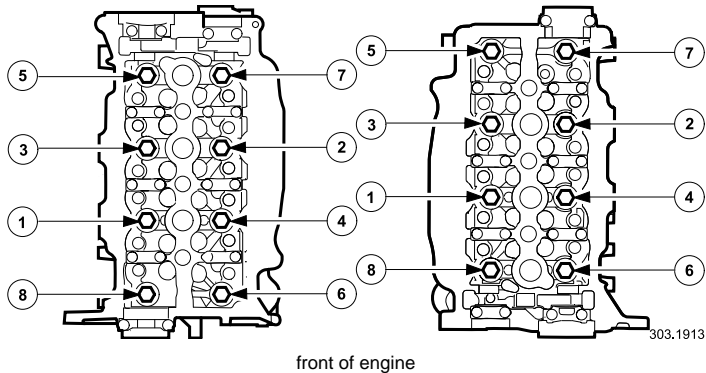

Notes

Note: Always use new bolts.

TDV6 3.0L

Apply each step in numerical sequence shown:

1. Tighten 1 to 8 – 20 Nm / 14 lbf.ft.

2. Tighten 1 to 8 – 40 Nm / 29 lbf.ft.

3. Tighten 1 to 8 – 80 Nm / 59 lbf.ft.

4. Tighten 1 to 8 – 180 degrees

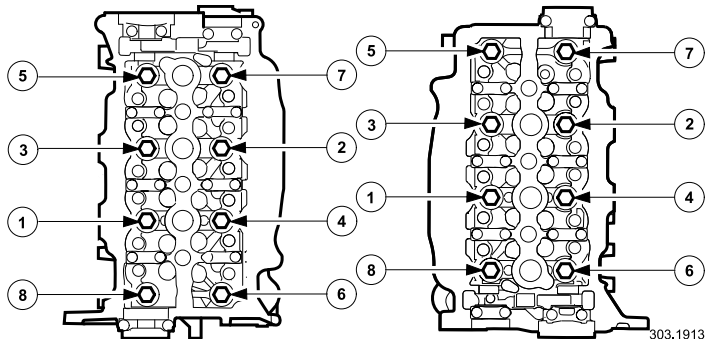

front of engine

303.1913

Notes

Note: Always use new bolts.

i6 3.2L

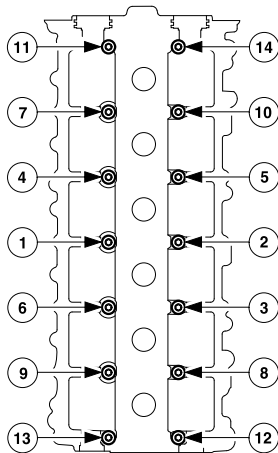
Notes

M128130

front of engine

Apply each step in numerical sequence shown:

1. Pre-torque 1 to 14 – 45 Nm / 33 lbf.ft.
2. Check 1 to 14 – 45 Nm / 33 lbf.ft. pre-torque
3. Angular tighten 1 to 14 – 90 degrees
4. Angular tighten 1 to 14 – 180 degrees

Note: Always use new bolts.

V6 4.0L

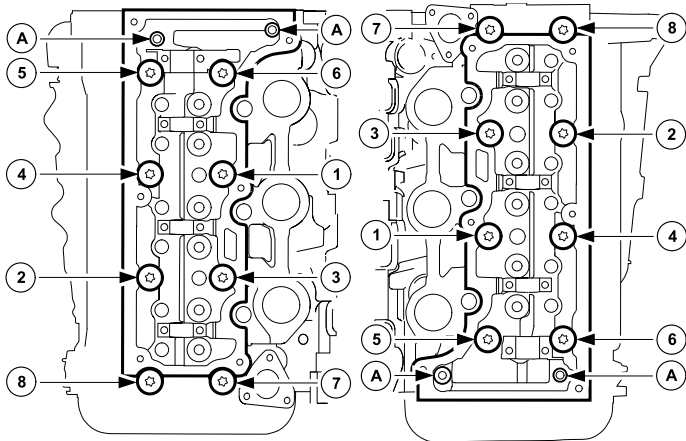

M128153

front of engine

Apply each step in numerical sequence shown:

1. Tighten 1 to 8 – 12 Nm / 9 lbf.ft.
2. Tighten 1 to 8 – 25 Nm / 18 lbf.ft.
3. Rotate 1 to 8 – 80 degrees
4. Rotate 1 to 8 – a further 80 degrees
5. Tighten bolts marked 'A' – 29 Nm / 21 lbf.ft.

Note: Always use new bolts.

Notes

V8 4.4L

Apply each step in numerical sequence shown:

- | | |
|---|-------------------------------------|
| 1. Tighten 1 to 10 – 20 Nm / 14 lbf.ft. | 4. Tighten 1 to 10 – 90 degrees |
| 2. Tighten 1 to 10 – 35 Nm / 26 lbf.ft. | 5. Tighten 'Y' – 23 Nm / 17 lbf.ft. |
| 3. Tighten 1 to 10 – 90 degrees | |

Notes

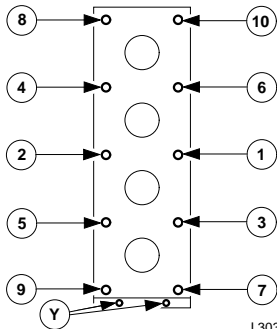

J.303.1544

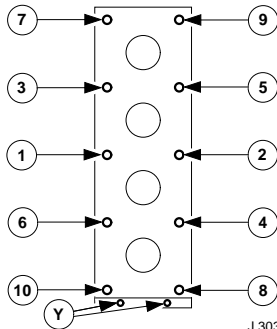

J.303.1545

front of engine

Note: Always use new bolts.

V8 5.0L

Apply each step in numerical sequence shown:

- | | |
|--|---|
| 1. Tighten 1 to 10 – 20 Nm / 15 lbf.ft. | 5. Tighten 1 to 10 – 120 degrees |
| 2. Tighten 1 to 10 – 35 Nm / 26 lbf.ft. | 6. Tighten 11 – 25 Nm / 18 lbf.ft. |
| 3. Release '1' then retighten to 35 Nm / 26 lbf.ft.; repeat procedure on '2' to '10' in sequence | 7. Tighten 12 to 13 – 12 Nm / 9 lbf.ft. |
| 4. Tighten 1 to 10 – 90 degrees | |

Notes

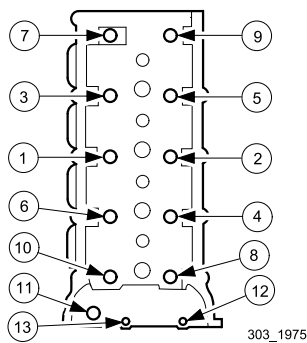
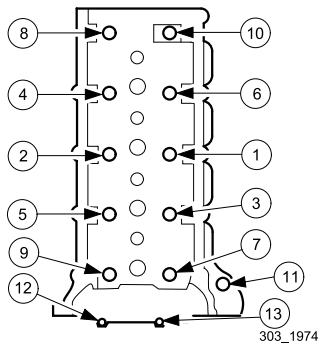

front of engine

Note: Always use new bolts.

Engine	Transmission	Transfer Box	Front Differential	Rear Differential
DISCOVERY 4 / LR4 – 2010 up to 2012 MY				
TDV6 2.7L Diesel (refer to engine oil section)	6 Ratio <i>Manual</i> : Castrol BOT 338 1.6 liters / 3.38 US pints	Shell TF0753 Initial fill: 1.50 liters 3.17 US pints Service fill: Fill to level plug	Castrol SAF-XO Initial fill: 0.68 liters 1.44 US pints Service fill: 0.61 liters 1.29 US pints	<i>Open Unit:</i> Castrol SAF-XO Initial fill: 1.23 liters / 2.59 US pints Service fill: 1.18 liters / 2.49 US pints
	6 Ratio <i>Automatic</i> : Shell ATF M-1375.4 Fill for life *			
TDV6 3.0L Diesel (refer to engine oil section)	6 Ratio <i>Manual</i> : Castrol BOT 338 1.6 liters / 3.38 US pints			
	6 Ratio <i>Automatic</i> : Shell ATF M-1375.4 Fill for life *			
V6 4.0L Gasoline (refer to engine oil section)	6 Ratio <i>Automatic</i> : Shell ATF M-1375.4 Fill for life *			<i>Electronic Unit:</i> Castrol BOT 720 Initial fill: 1.77 liters / 3.74 US pints Service fill: 1.72 liters / 3.63 US pints
V8 5.0L Gasoline (refer to engine oil section)				

Note: * Refer to TOPIx for top-up procedure.

Notes

Engine	Transmission	Transfer Box	Front Differential	Rear Differential
DISCOVERY 4 / LR4 – 2012 MY onwards				
TDV6 2.7L Diesel (refer to engine oil section)	6 Ratio <i>Automatic</i> : Shell ATF M-1375.4 Fill for life *	Shell TF0753 Initial fill: 1.50 liters 3.17 US pints Service fill: Fill to level plug	Castrol SAF-XO Initial fill: 0.68 liters 1.44 US pints Service fill: 0.61 liters 1.29 US pints	<i>Open Unit</i> : Castrol SAF-XO Initial fill: 1.23 liters / 2.59 US pints Service fill: 1.18 liters / 2.49 US pints
TDV6 3.0L Diesel (refer to engine oil section)	6 Ratio <i>Automatic</i> : Shell ATF M-1375.4 Fill for life *			<i>Electronic Unit</i> : Castrol BOT 720 Initial fill: 1.77 liters / 3.74 US pints Service fill: 1.72 liters / 3.63 US pints
	8 Ratio Automatic : Shell L12108 or Lifeguard 8. Fill for life *			
V8 5.0L Gasoline (refer to engine oil section)	6 Ratio <i>Automatic</i> : Shell ATF M-1375.4 Fill for life *			

Note: * Refer to *TOPix* for top-up procedure.

Notes

Engine	Transmission	Transfer Box	Front Differential	Rear Differential
DISCOVERY 3 / LR3 – 2007 up to 2010 MY				
TDV6 2.7L Diesel (refer to engine oil section)	6 Ratio <i>Manual</i> : Castrol BOT 338 1.6 liters / 3.38 US pints	Shell TF0753 Initial fill: 1.50 liters 3.17 US pints Service fill: Fill to level plug	Castrol SAF-XO Initial fill: 0.68 liters 1.44 US pints Service fill: 0.61 liters 1.29 US pints	<i>Open Unit:</i> Castrol SAF-XO Initial fill: 1.15 liters / 2.43 US pints Service fill: 1.10 liters / 2.32 US pints <i>Electronic Unit:</i> Castrol BOT 720 Initial fill: 1.60 liters / 3.38 US pints Service fill: 1.55 liters / 3.27 US pints
V6 4.0L Gasoline (refer to engine oil section)	6 Ratio <i>Automatic</i> : Shell ATF M-1375.4 Fill for life. Refer to TOPIx for top-up procedure.			
V8 4.4L Gasoline (refer to engine oil section)				

Notes

Engine	Transmission	Power Transfer Unit	Active On-demand Coupling	Rear Differential
FREELANDER 2 / LR2 – 2007 up to 2011 MY				
TD4 2.2L Diesel (refer to engine oil section)	6 Ratio Manual: Castrol MTF 97309 2 liters / 4.2 US pints	Castrol BOT 118 Plus Initial fill: 0.75 liters 1.6 US pints Service fill: Refer to TOPlx	STAT OIL SL01-301 Initial fill: 0.65 liters 1.4 US pints Service fill: Refer to TOPlx	Castrol EPX 80W-90 0.7 liters 1.5 US pints
	6 Ratio Automatic: Esso JWS3309 US 7 liters 15 US pints			
i6 – 3.2L Gasoline (refer to engine oil section)				

Notes

Engine	Transmission	Power Transfer Unit	Active On-demand Coupling	Rear Differential
FREELANDER 2 / LR2 – 2011 MY onwards				
TD4 2.2L Diesel 2WD (refer to engine oil section)	6 Ratio <i>Manual</i> : Castrol BOT 350 M3 2 liters / 4.2 US pints	–	–	–
TD4 2.2L Diesel 4WD (refer to engine oil section)	6 Ratio <i>Manual</i> : Castrol BOT 350 M3 2 liters / 4.2 US pints 6 Ratio <i>Automatic</i> : Nippon AW-1 ATF 7 liters 15 US pints	Castrol BOT 118 Plus Initial fill: 0.75 liters 1.6 US pints Service fill: Refer to TOPlx	STAT OIL SL01-301 Initial fill: 0.65 liters 1.4 US pints Service fill: Refer to TOPlx	Castrol EPX 80W-90 0.7 liters 1.5 US pints
i6 – 3.2L Gasoline (refer to engine oil section)	6 Ratio <i>Automatic</i> : Esso JWS3309 US 7 liters 15 US pints			

Notes

Engine	Transmission	Transfer Box	Front Differential	Rear Differential
DEFENDER – 2007 up to 2012 MY				
TDCi 2.4L Diesel (refer to engine oil section)	6 Ratio <i>Manual</i> : Castrol Syntrans Multivehicle 75W-90 2.4 liters 5.1 US pints	Castrol Syntrox 75W-90 or Texaco Multigear 75W-90R 2.3 liters 4.8 US pints	Castrol EPX 80W-90 or Texaco Geartex EP85W-90 1.6 liters 3.4 US pints	Castrol EPX 80W-90 or Texaco Geartex EP85W-90 1.6 liters 3.4 US pints
DEFENDER – 2012 MY onwards				
TDCi 2.2L Diesel (refer to engine oil section)	6 Ratio <i>Manual</i> : Castrol Syntrans Multivehicle 75W-90 2.4 liters 5.1 US pints	Castrol Syntrox 75W-90 or Texaco Multigear 75W-90R 2.3 liters 4.8 US pints	Castrol EPX 80W-90 or Texaco Geartex EP85W-90 1.6 liters 3.4 US pints	Castrol EPX 80W-90 or Texaco Geartex EP85W-90 1.6 liters 3.4 US pints

Notes

Engine	Refrigerant	Zone	Refrigerant Charge Weight	Compressor Oil Quantity	Compressor Oil
DISCOVERY 4 / LR4 – 2010 up to 2012 MY					
TDV6 2.7L Diesel	R134a	Two	600 ± 25 g / 21.2 ± 0.9 oz.	130 ml / 4.4 US fl oz.	Denso ND–8 PAG oil
		Four	900 ± 25 g / 31.7 ± 0.9 oz.	170 ml / 5.7 US fl oz.	
TDV6 3.0L Diesel	R134a	Two	600 ± 25 g / 21.2 ± 0.9 oz.	110 ml / 3.7 US fl oz.	Sanden SP–10 PAG oil
		Four	900 ± 25 g / 31.7 ± 0.9 oz.	160 ml / 5.4 US fl oz.	
V6 4.0L Gasoline	R134a	Two	600 ± 25 g / 21.2 ± 0.9 oz.	130 ml / 4.4 US fl oz.	Denso ND–8 PAG oil
		Four	900 ± 25 g / 31.7 ± 0.9 oz.	170 ml / 5.7 US fl oz.	
V8 5.0L Gasoline	R134a	Two	650 ± 25 g / 22.9 ± 0.9 oz.	110 ml / 3.7 US fl oz.	Sanden SP–10 PAG oil
		Four	900 ± 25 g / 31.7 ± 0.9 oz.	160 ml / 5.4 US fl oz.	
DISCOVERY 4 / LR4 – 2012 MY onwards					
TDV6 2.7L Diesel	R134a	Two	600 ± 25 g / 21.2 ± 0.9 oz.	130 ml / 4.4 US fl oz.	Denso ND–8 PAG oil
		Four	900 ± 25 g / 31.7 ± 0.9 oz.	170 ml / 5.7 US fl oz.	
TDV6 3.0L Diesel	R134a	Two	600 ± 25 g / 21.2 ± 0.9 oz.	110 ml / 3.7 US fl oz.	Sanden SP–10 PAG oil
		Four	900 ± 25 g / 31.7 ± 0.9 oz.	160 ml / 5.4 US fl oz.	
V8 5.0L Gasoline	R134a	Two	650 ± 25 g / 22.9 ± 0.9 oz.	110 ml / 3.7 US fl oz.	Sanden SP–10 PAG oil
		Four	900 ± 25 g / 31.7 ± 0.9 oz.	160 ml / 5.4 US fl oz.	

Notes

Engine	Refrigerant	Zone	Refrigerant Charge Weight	Compressor Oil Quantity	Compressor Oil
DISCOVERY 3 / LR3 – 2007 up to 2010 MY					
TDV6 2.7L Diesel	R134a	Two	550 ± 25 g / 19.4 ± 0.9 oz.	130 ml / 4.4 US fl oz.	Denso ND-8 PAG oil
		Four	810 ± 25 g / 28.6 ± 0.9 oz.	170 ml / 5.7 US fl oz.	
V6 4.0L Gasoline	R134a	Two	600 ± 25 g / 21.2 ± 0.9 oz.	130 ml / 4.4 US fl oz.	Denso ND-8 PAG oil
		Four	900 ± 25 g / 31.7 ± 0.9 oz.	170 ml / 5.7 US fl oz.	
V8 4.4L Gasoline	R134a	Two	600 ± 25 g / 21.2 ± 0.9 oz.	130 ml / 4.4 US fl oz.	Denso ND-8 PAG oil
		Four	900 ± 25 g / 31.7 ± 0.9 oz.	170 ml / 5.7 US fl oz.	
FREELANDER 2 / LR2 – 2007 MY onwards					
TD4 2.2L Diesel	R134a	Single and Two	730 ± 10 g / 25.7 ± 0.35 oz.	200 ml / 6.8 US fl oz.	LR004879
i6 3.2L Gasoline *	R134a	Single and Two	730 ± 10 g / 25.7 ± 0.35 oz.	150 ml / 5.1 US fl oz.	Denso ND-8 PAG oil
i6 3.2L Gasoline **	R134a	Single and Two	730 ± 10 g / 25.7 ± 0.35 oz.	110 ml / 3.7 US fl oz.	Sanden SP-10 PAG oil

Note: * Up to VIN: AH163415.

Note: ** VIN onwards AH163416.

Notes

Engine	Refrigerant	Zone	Refrigerant Charge Weight	Compressor Oil Quantity	Compressor Oil
DEFENDER – 2007 up to 2012 MY					
TDCi 2.4L Diesel	R134a	Single	600 ± 25 g / 21.2 ± 0.9 oz.	130 ml / 4.4 US fl oz.	Sanden SP-10 PAG oil
DEFENDER – 2012 MY onwards					
TDCi 2.2L Diesel	R134a	Single	600 ± 25 g / 21.2 ± 0.9 oz.	130 ml / 4.4 US fl oz.	Sanden SP-10 PAG oil

Notes

The illustrations, technical information, data and descriptive text in this issue, to the best of our knowledge, were correct at the time of going to print.

No part of this publication may be copied, reproduced, stored in a data processing system, nor transmitted by electronic, mechanical, photographic or any other means. The storage or translation of this publication and the editing, in summary or expanded form is not permitted except with prior written permission of Land Rover. The same conditions apply to parts of this publication and their use in other publications.

No liability can be accepted for any inaccuracies or omissions in this publication, although every possible care has been taken to make it as complete and accurate as possible.